



PROJECT	
ITEM #	
QUANTITY	DATE
APPROVAL	

KCI & KCI-NU

Mobile Ice Pan Serving Counters

Short Form Specifications

Exterior Body is seamless, one-piece molded fiberglass, having perfectly smooth exterior surface with all corners fully rounded. The fiberglass reinforced polyester (F.R.P.) is molded with permanent color. Stress points are internally reinforced.

Exterior top is constructed of 14-gauge stainless steel, welded, ground and polished into one integral unit. Top is fabricated with square exterior corners.

Insulated ice pan is 7" (17.8cm) deep and constructed of 22-gauge stainless steel. A removable, perforated false bottom 1" (2.5cm) high, constructed of stainless steel, is supplied. The ice pan is separated from the exterior top by a Therma Brake and fully insulated with foam in place polyurethane insulation. Ice pan is equipped with a 1" (2.5cm) I.P.S. drain plumbed to drain valve located at the bottom of the unit.

Casters; unit is mounted on 5" (12.7cm) diameter swivel casters with non-marking polyolefin tires and plate brakes. Overall height of caster assembly is 6" (15.2cm).

The following applies to KCI Series only

KCI units have a two door dry compartment constructed of 18-gauge stainless steel. Compartment is equipped with an adjustable height stainless steel shelf. Doors are double-wall construction, with stainless steel front panel.

- KCI-36 one compartment, 24" wide with one door
- KCI-50, one compartment, 36" wide with two doors
- KCI-60, one compartment, 48" wide with two doors
- KCI-74, one compartment, 48" wide with two doors
- KCI-96, two compartments, each 36" wide with two doors each



Model KCU-50-NU
shown with options E, H & P

Optional Accessories and Modifications

- A) 12" (30.5cm) wide stainless steel fold-down tray slide
 - C) 10" (25.4cm) wide three-bar fold-down tray slide
 - D) 10" (25.4cm) wide composite fold-down cutting boards
 - E) 10" (25.4cm) wide stainless steel fold-down work shelf
 - F) Line-up interlock device
 - G) Glass-front counter protector
 - H) Two tier display with glass shelves and sneezeguards
 - HD) Dual service two tier display with sneezeguards
 - I) Three tier display with glass shelves and sneezeguards
 - J) 12" (30.5cm) wide 18-gauge stainless steel overshef
 - KS) Single service flip-up sneezeguard
 - KD) Double service flip-up sneezeguard
 - L) *Fluorescent or incandescent light fixtures (specify)
 - P) Open understorage with shelf (KCI-NU Series only)
 - Q) *120V/60Hz/1ø, 10 amp convenience outlet with breaker
 - SG5A) Single dry insert with doors (KCI-NU units only)
 - SG5B) Double dry insert with doors (KCI-NU units only)
 - SG20) *Refrigerated understorage (60" unit or longer)
 - ST) Stainless steel trim strips
 - U) 14" x 30" (35.6cm x 76.2cm) stainless steel end drop shelf
 - UU) Molded fiberglass trim strips
 - V) 6" (15.2cm) high adjustable stainless steel legs in lieu of casters
- *Inclusion of these options will alter the electrical specifications of unit.*



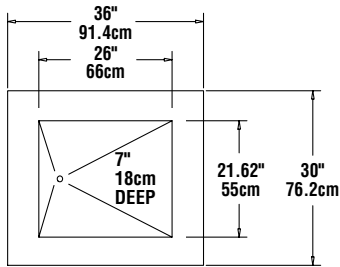

**PLAN VIEW
KCI-36/
KCI-36-NU**

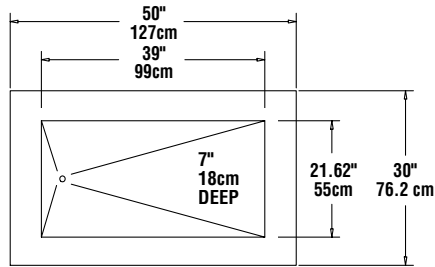

**PLAN VIEW
KCI-50/
KCI-50-NU**

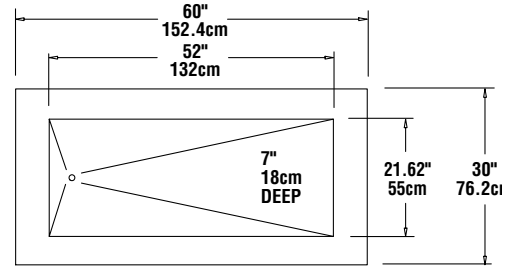

**PLAN VIEW
KCI-60/
KCI-60-NU**

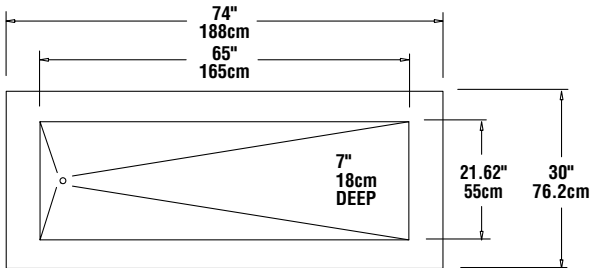

**PLAN VIEW
KCI-74/
KCI-74-NU**

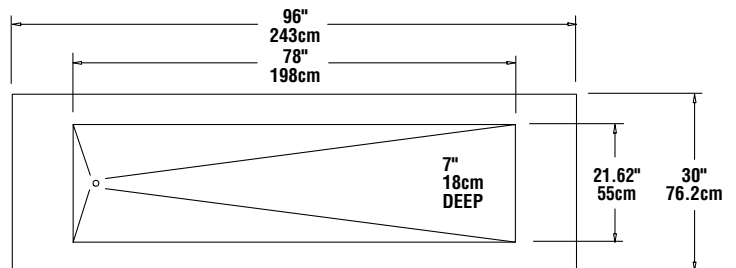

**PLAN VIEW
KCI-96/
KCI-96-NU**

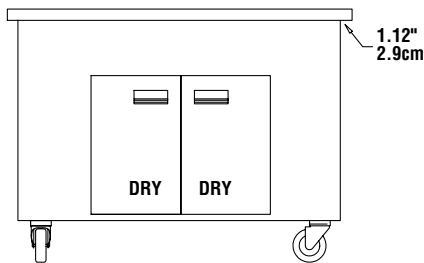

**ELEVATION VIEW
KCI-50 THROUGH KCI-74
(KCI-96 two 36" compartments
not show)**

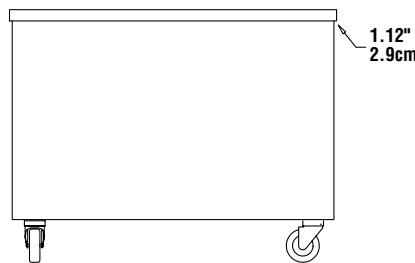

**ELEVATION VIEW
ALL KCI-NU MODELS**

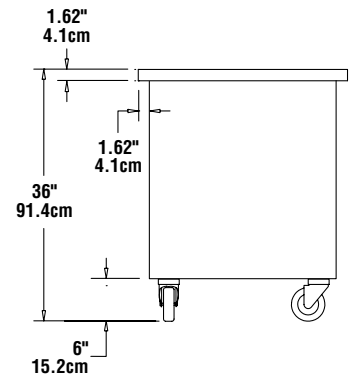

**END VIEW
ALL MODELS**

Mechanical Data—Standard Unit

MODEL NUMBER	# OF DOORS	# OF SHELVES	SHIP WEIGHT	MODEL NUMBER	SHIP WEIGHT
KCI-36	2	1	240 lbs/109 kg	KCI-36-NU	200 lbs/91 kg
KCI-50	2	1	285 lbs/129 kg	KCI-50-NU	245 lbs/111 kg
KCI-60	2	1	320 lbs/145 kg	KCI-60-NU	280 lbs/127 kg
KCI-74	2	1	360 lbs/163 kg	KCI-74-NU	330 lbs/150 kg
KCI-96	4	2	400 lbs/181 kg	KCI-96-NU	380 lbs/172 kg