

SHORT SERIES™ DIRECT STEAM KETTLES

RIM HEIGHTS - 32.1" (40 GALLON), 34.8" (60 & 80 GALLONS)
 STATIONARY, FULL STEAM JACKETED
 40, 60 OR 80 GALLONS (150, 225 OR 300 LITERS)

Project _____
 Item _____
 Quantity _____
 FCSI Section 11400 _____
 Approved _____
 Date _____

Models

- KDL-40-SH
- KDL-60-SH
- KDL-80-SH



Standard Features

- 50 psi Steam Jacket Rating and 50 psi chrome plated Safety Valve
- Type 304 Stainless Steel with #4 finish on kettle and supports
- Spring-assisted, hinged, rotatable, domed Stainless Steel Cover
- 2" Tangent Draw-Off Valve with Drain Strainer
- Faucet Mounting Bracket (FBK)
- Steam Control Inlet Valve
- Condensate Drain Valve with insulated handle
- Level adjustable flanged feet for floor bolting
- Typical approvals include NSF and ASME

Short Form Specifications

Cleveland Direct Steam Stationary Kettle, Model KDL-()SH, 32" rim height (40 gal), 34" rim height (60, 80 gal) fully steam jacketed, 50 psi Steam Jacket Rating, spring-assisted rotatable Domed cover, Faucet Bracket, 2" Tangent Draw-off Valve; heavy re-enforced Rolled Rim.

Options & Accessories

- 316 Stainless Steel Interior Liner (316G)
- Factory installed Steam Control Kit, consisting of a Steam Trap, Condensate Strainer and Check Valve (SCK1)
- 3" Tangent Draw-off Valve (TD3)
- 3" Butterfly Valve (BV3)
- Hot & Cold Water Faucet (DPK)
- Pressure Reducing Valve for regulating incoming steam pressure over 45 psi (PRVK)
- Kettle Accessory Kit (KAK)
- Tri-Basket Strainer Support Systems (TBS)
- Kettles Markings (KM)
- Measuring Strips (MS)
- Correctional Packages
- Heat Deflector Shield (HS001)
- Insulated Out Jacket (IOJ)

CAPACITIES: (in 8 oz. servings,
other sizes may be calculated.)
40 Gallon / 150 liters . . . 640 servings
60 Gallon / 225 liters . . . 960 servings
80 Gallon / 300 liters . . . 1280 servings

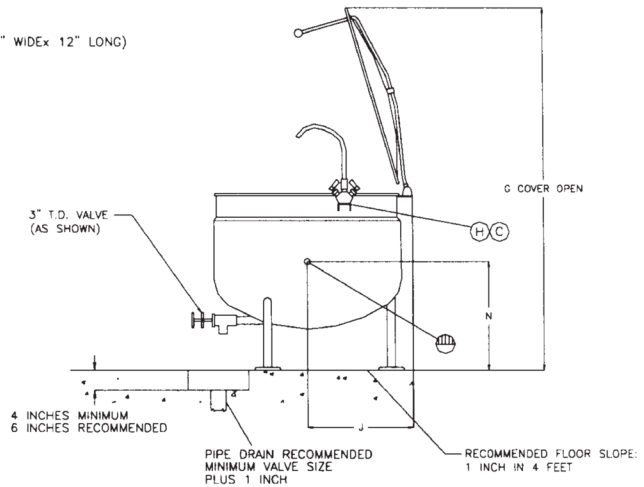
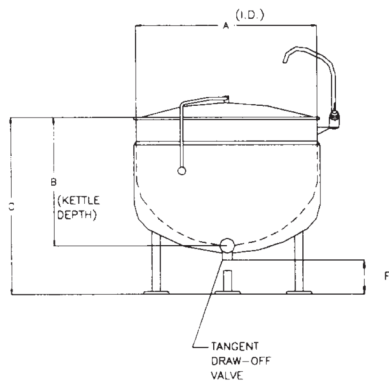
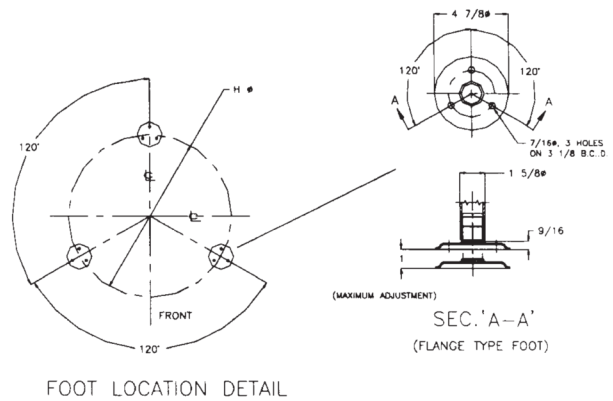
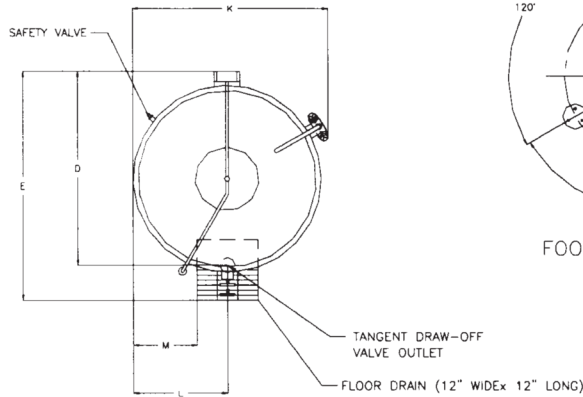

MODEL NO		A	B	C	D	E	F	G	H	J	K	L	M	N
KDL-40SH	IN	29.5	19.2	32.1	34.2	41.2	10.7	62.6	26.3	18.5	34.7	15.7	9.7	22.7
	mm	749	488	815	869	1046	272	1590	668	470	881	399	246	577
KDL-60SH	IN	33	22.6	34.8	36.6	43.6	9.7	68.8	29.8	20.2	38.2	17.5	11.5	23.8
	mm	850	574	884	930	1107	246	1748	757	513	970	445	292	605
KDL-80SH	IN	35.5	25.3	34.8	38.5	45.5	7.06	71.3	32.3	21.5	40.7	18.7	12.7	21.9
	mm	902	643	884	978	1156	179	1811	820	546	1034	475	323	556

DIRECT STEAM	DRAINAGE	WATER	CLEARANCE
Steam Supply * Furnish 3/8" IPS minimum line * Operating Pressure 5-45 psi with a 50 psi Safety Valve	1/2" N.P.T. Condensate Return with Strainer and Trap	1/2" diameter Soft Copper Tubing each When ordered with optional faucet	RIGHT = 0 LEFT = 0 REAR = 0

NOTES:

Cleveland Range reserves right of design improvement or modification, as warranted.
 Many regional, state and local codes exist and it is the responsibility of the owner and installer to comply with the codes.
 Installation of backflow preventers, vacuum breakers and other specific code requirements is the responsibility of the owner and installer.
 Cleveland Range equipment is built to comply with applicable standards for manufacturers. Included among those approval agencies are U.L., A.G.A., NSF, ASME/N.Bd., CSA, CGA, ETL and others. (NOT TO SCALE)

Direct Steam Kettles