



STAINLESS STEEL Ice Bins 18" and 21" Wide Units



SLI Series
18" Wide Units



CRI Series
21" Wide Units

Item #: _____ Qty #: _____

Model #: _____

Project #: _____

MATERIAL:

Ice Bin, Front Apron, Backsplash: 22 gauge, 300 stainless steel
Sides: 20 gauge, 430 stainless steel
Understructure: 22 gauge galvaneal front/back;
 11 gauge electrogalvaneal leg channel
Legs: 1 5/8" O.D. 18 gauge, galvanized steel
 with adjustable plastic bullet feet
Ice Bin Insulation: Foam Insulation

MECHANICAL:

1" IPS drain.

OPTIONAL:

- SU-10B** - 10" stainless steel leg upgrade (for 16" deep ice bins)
- SU-10C** - 14" stainless steel leg upgrade (for 12" deep ice bins)
- SU-30** - Soda chase provision
- SU-40** - Prep unit for installation of speed rail
- SSC-12** - Sliding cover for 12" ice bin
- SSC-24** - Sliding cover for 24" ice bin
- SSC-30** - Sliding cover for 30" ice bin
- SSC-36** - Sliding cover for 36" ice bin
- SSC-42** - Sliding cover for 42" ice bin
- SSC-48** - Sliding cover for 48" ice bin



Optional Sliding
Stainless Steel Cover Shown

FEATURES:

- Insulated ice bins are 12" or 16" deep.
- 4" backsplash.
- Two removable injection molded 3-pack plastic bottle racks.
- Galvanized legs with adjustable plastic bullet feet.
- Adjustable galvanized side cross-bracing.
- CRI Series** has rear deck for extra storage.

NOTE: Bottle Racks Must Be Removed For NSF Compliance & For Use With Optional Cover.

18" WIDE Model #	Approx. Weight	Approx. Cu. Ft.	21" WIDE Model #	Approx. Weight	Approx. Cu. Ft.	O.A. Length (A)	Dist. To Drain (B)	Ice Bin Depth (C)	O.A. Height of Bin (D)	O.A. Leg Height (E)	Inside Bin Width (F)	Ice Bin Capacity
SLI-12-12	26 lbs.	6	CRI-12-12	35 lbs.	6	12"	6"	12" DEEP	14"	14"	9 5/8"	35 lbs.
SLI-12-24	52 lbs.	7	CRI-12-24	61 lbs.	8	24"	12"		14"	14"	21 5/8"	77 lbs.
SLI-12-30	60 lbs.	11	CRI-12-30	69 lbs.	11	30"	15"		14"	14"	27 5/8"	98 lbs.
SLI-12-36	68 lbs.	13	CRI-12-36	77 lbs.	13	36"	18"		14"	14"	33 5/8"	119 lbs.
SLI-12-42	72 lbs.	13	CRI-12-42	81 lbs.	13	42"	21"		14"	14"	39 5/8"	140 lbs.
SLI-12-48	87 lbs.	14	CRI-12-48	96 lbs.	14	48"	24"		14"	14"	45 5/8"	161 lbs.
SLI-16-24	68 lbs.	7	CRI-16-24	75 lbs.	8	24"	12"	16" DEEP	18"	10"	21 5/8"	100 lbs.
SLI-16-30	69 lbs.	12	CRI-16-30	76 lbs.	12	30"	15"		18"	10"	27 5/8"	127 lbs.
SLI-16-36	70 lbs.	16	CRI-16-36	78 lbs.	17	36"	18"		18"	10"	33 5/8"	155 lbs.



Customer Service Available To Assist You **1-800-645-3166** 8:30 am - 8:00 pm E.S.T.

For Orders & Customer Service:

Email: customer@advancetabco.com or Fax: 631-242-6900

For Smart Fabrication™ Quotes:

Email: smartfab@advancetabco.com or Fax: 631-586-2933

DIMENSIONS and SPECIFICATIONS

TOL Overall: $\pm .500"$ Interior: $\pm .250"$

ALL DIMENSIONS ARE TYPICAL

SLI Series

NON-COLD PLATE ICE BINS

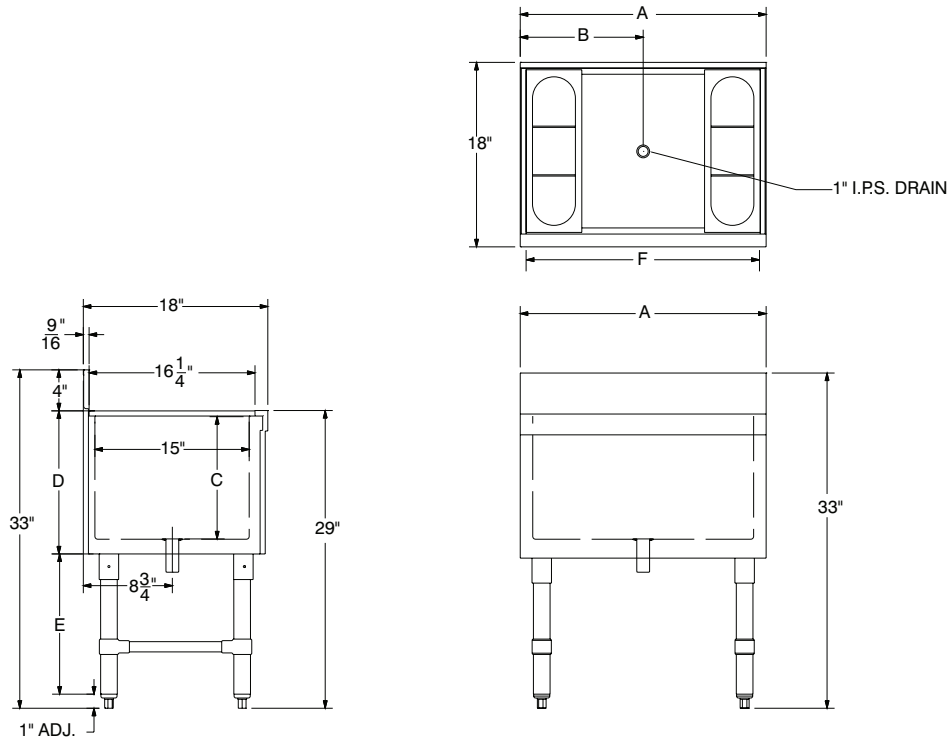

CRI Series

