



STAINLESS STEEL
REGALINE SINKS
 Four Compartments - Two Drainboards



93 & 9 SERIES
 Welded Side
 Cross-Bracing



94 SERIES
 Welded Side & Adjustable
 Front & Rear Cross-Bracing

YES! It's SeaLess!

Item #: _____ Qty #: _____
 Model #: _____
 Project #: _____

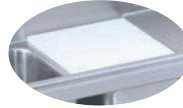

Recessed Bowl Surface
 Accommodates
 Poly-Vance Cutting Boards
 & Sink Covers



CONSTRUCTION:

All TIG welded.
 Welded areas blended to match adjacent surfaces and to a satin finish.

Gussets welded to a die-embossed reinforcing channel.

MATERIALS:

- Spec-Line (94 Series):** 14 gauge type 304 stainless steel
 11" High Splash.
- Standard (93 Series):** 16 gauge type 304 stainless steel
 8" High Splash.
- Super Saver (9 Series):** 18 gauge type 304 stainless steel
 8" High Splash.

- LEGS:**
- 1 5/8" diameter tubular stainless steel.
 - Stainless steel gussets & channels.
 - Stainless Steel 1" adjustable bullet feet.

FEATURES:

Tile edge for ease of installation.
 One piece **Deep Drawn** sink bowls with integral drainboards with splash.
 All sink bowls have a large liberal 3" radius.
 Placement of the welded leg assembly ensures stability and furnishes direct support of the column load requirement for the entire sink unit.
"94" Series is supplied with adjustable front and rear cross brace featuring leg casting to secure left to right cross bracing.

Bowl Size	O.A. Length	DRBD. Size	SPEC-LINE 94 Series		STANDARD 93 Series		SUPER SAVER 9 Series		Cu. Ft.
			Model #	WT.	Model #	WT.	Model #	WT.	
16" x 20"	110"	18"	14 Ga. 304 S/S 14" Water Level		16 Ga. 304 S/S 12" Water Level		18 Ga. 304 S/S 12" Water Level		
	122"	24"	94-4-72-18RL	210 lbs.	93-4-72-18RL	183 lbs.	9-4-72-18RL	175 lbs.	58
	146"	36"*	94-4-72-24RL	275 lbs.	93-4-72-24RL	252 lbs.	9-4-72-24RL	241 lbs.	64
20" x 20"	126"	18"	94-4-72-36RL	313 lbs.	93-4-72-36RL	287 lbs.	9-4-72-36RL	274 lbs.	86
	138"	24"	94-24-80-18RL	293 lbs.	93-24-80-18RL	268 lbs.	9-24-80-18RL	259 lbs.	87
	162"	36"*	94-24-80-24RL	312 lbs.	93-24-80-24RL	286 lbs.	9-24-80-24RL	275 lbs.	95
18" x 24"	162"	36"*	94-24-80-36RL	351 lbs.	93-24-80-36RL	322 lbs.	9-24-80-36RL	308 lbs.	111
	118"	18"	94-64-72-18RL	358 lbs.	93-64-72-18RL	346 lbs.	9-64-72-18RL	336 lbs.	82
	130"	24"	94-64-72-24RL	372 lbs.	93-64-72-24RL	355 lbs.	9-64-72-24RL	344 lbs.	90
24" x 24"	154"	24"	94-64-72-36RL	409 lbs.	93-64-72-36RL	392 lbs.	9-64-72-36RL	378 lbs.	106
	178"	36"*	94-44-96-24RL	395 lbs.	93-44-96-24RL	361 lbs.	9-44-96-24RL	348 lbs.	106
	178"	36"*	94-44-96-36RL	431 lbs.	93-44-96-36RL	398 lbs.	9-44-96-36RL	382 lbs.	122
20" x 28"	126"	18"	94-84-80-18RL	382 lbs.	93-84-80-18RL	361 lbs.	9-84-80-18RL	350 lbs.	97
	138"	24"	94-84-80-24RL	402 lbs.	93-84-80-24RL	374 lbs.	9-84-80-24RL	361 lbs.	106
	162"	36"*	94-84-80-36RL	442 lbs.	93-84-80-36RL	411 lbs.	9-84-80-36RL	395 lbs.	124
* Regalines with 36" Drainboards are Supplied with Two Additional Legs (per drainboard) for Support.			14" Water Level 17" Flood Level		12" Water Level 15" Flood Level		12" Water Level 15" Flood Level		

All Sinks Require Two Faucets

Weights & Cubes Are Approximate



Customer Service Available To Assist You **1-800-645-3166** 8:30 am - 7:00 pm E.S.T.

For Orders & Customer Service:
 Email: customer@advancetabco.com or Fax: 631-242-6900

For Smart Fabrication™ Quotes:
 Email: smartfab@advancetabco.com or Fax: 631-586-2933

DIMENSIONS and SPECIFICATIONS

TOL Overall: ± .500"
Interior: ± .250"

ALL DIMENSIONS ARE TYPICAL

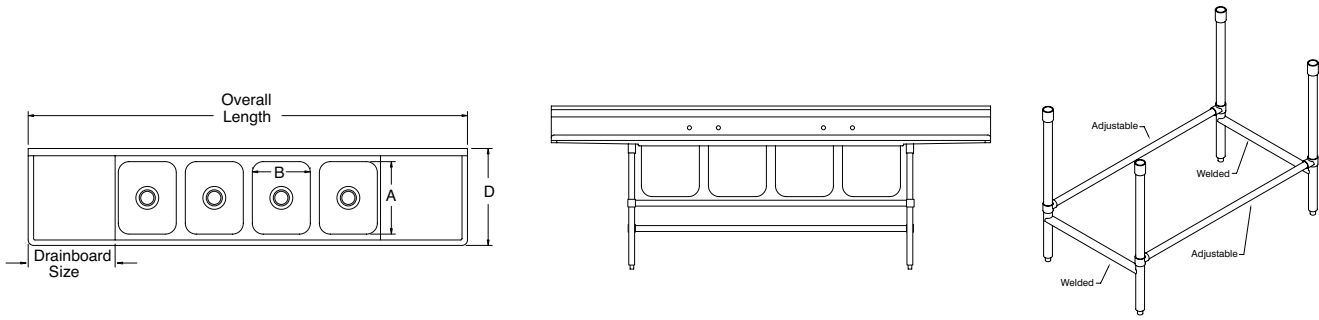

94 Series Includes front & Rear Adjustable Cross Bracing (Shown Above)

DESCRIPTION

BOWL (SIZE)	Overall Length	DRBD (SIZE)	Recommended Use	94 SERIES					9 & 93 SERIES								
				A	B	C	D	V	W	X	Y	Z	V	W	X	Y	Z
16x20	110"	18"	DISH SINKS	20"	16"	13 5/8"	27"	38"	11"	14"	20"	45"	38"	8"	12"	22"	42"
	122"	24"															
	146"	*36"															
20x20	126"	18"	DISH & POT SINKS	20"	20"	13 5/8"	27"	38"	11"	14"	20"	45"	38"	8"	12"	22"	42"
	138"	24"															
	162"	*36"															
18x24	118"	18"	POT & PAN SINKS	24"	18"	15 5/8"	31"	38"	11"	14"	20"	45"	38"	8"	12"	22"	42"
	130"	24"															
	154"	*36"															
24x24	154"	24"	POT SINKS	24"	24"	15 5/8"	31"	38"	11"	14"	20"	45"	38"	8"	12"	22"	42"
	178"	*36"															
20x28	126"	18"	PAN SINKS	28"	20"	17 5/8"	35"	38"	11"	14"	20"	45"	38"	8"	12"	22"	42"
	138"	24"															
	162"	*36"															

All Sinks Require Two Faucets

* Regalines with 36" Drainboards are Supplied with Two Additional Legs (per drainboard) for Support.

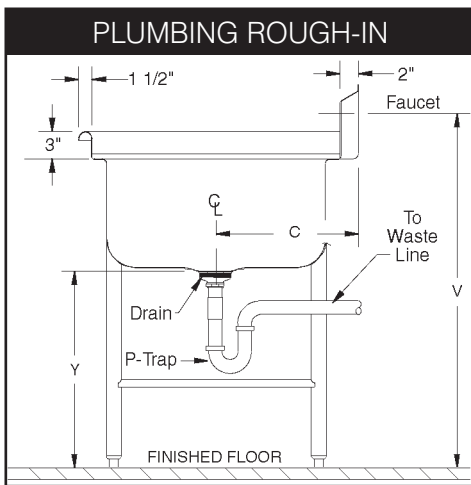

MECHANICAL:

- Supply is 1/2" IPS hot & cold.
- Faucet holes on 8" centers.
- Faucets are not included (see accessories).
- Waste drains are 1 1/2" IPS S/S basket type, located in center of sink bowl, and are included.

