

PRODIGY
PLUS

Eclipse™

EH222 - 800-1000lb Cube Ice Machine

Prodigy Plus® Eclipse® Remote Cooled Modular Cube Ice Machine

The world's smartest cuber.

As the world's only self-monitoring cuber, the new Scotsman Prodigy Plus® cube ice machines make it easier than ever to maintain your equipment and save money. Whether it's the advanced ice level control or an optional feature board for quick diagnostics, this is ice-making re-imagined. And with intuitive technology like AutoAlert™ indicator lights, a reduced operational footprint and easy-access service from the front panel, Prodigy Plus® cubers are simply the smartest, most reliable way to create fresh-tasting ice — every time.



Remote condenser.

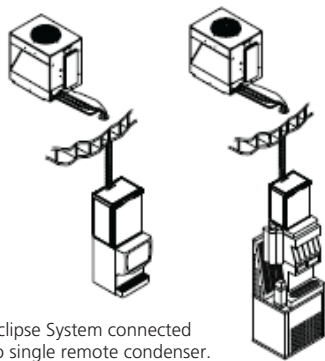

Eclipse System connected to single remote condenser.

The Prodigy Plus® difference.

- AutoAlert™ indicator lights for better visibility
- Operational footprint among the industry's smallest
- Industry-exclusive QR code instantly connects users to service information and warranty history
- One-touch cleaning reduces labor costs and saves time
- Front-located air filter for more efficient operation
- Self-aligning front panel for easy access to key components
- Patented WaterSense purge control automatically reduces scale buildup
- Patented Harvest Assist efficiently moves cube ice to the bin
- Smart-Board™ advanced feature module available for additional diagnostic capabilities
- Optional Vari-Smart™ ice level control allows operators to customize ice levels
- Antimicrobial protection guards internal surfaces between cleanings
- A full range of water- and energy-saving features



24 Hour Volume Production

EH222 800lb			EH222 1000lb		
70°F/21°C	Air	90°F/32°C	70°F/21°C	Air	90°F/32°C
50°F/10°C	Water	70°F/21°C	50°F/10°C	Water	70°F/21°C
850/386	lb/kg	700/318	1030/468	827/375	lb/kg



Modular Bin Options

Model Number*	Dimensions W" x D" x H"	Bin Application		Ship Weight lb/kg
		Capacity lb/kg	Finish	
ID150/ABS	22 x 30 x 35	-	Stainless Steel	149/68
ID200	30 x 30 x 35	-	Stainless Steel	183/83
ID250	30 x 30 x 39	-	Stainless Steel	188/85
BH1100BB	48 x 34 x 50**	1100/499	SS w/ GBB†	280/127
BH1100SS	48 x 34 x 50**	1100/499	Stainless Steel	280/127

* Contact Scotsman for bin top requirements. ** Add 6" Height for bin legs.
† Stainless steel with galvanized back & bottom.



Cube Ice

Common ice form, ideal for mixed drinks.



Small Cube
7/8" x 7/8" x 3/8"
(2.22 x 2.22 x .95 cm)



Certification



Warranty

- 3 years parts and labor on all components.
- 5 years parts and labor on the evaporator.
- 5 years parts on the compressor and condenser.
- Warranty valid in North, South & Central America for commercial installations.
- Contact factory for warranty in other regions.
- Residential Applications: 1 year parts and labor

EH222 - 800-1000lb Cube Ice Machine

Scotsman®

• 101 Corporate Woods Parkway, Vernon Hills, IL 60061 •
• 1-800-SCOTSMAN • Fax: 847-913-9844 • www.scotsman-ice.com • customer.relations@scotsman-ice.com •

EH222 - 800-1000lb Cube Ice Machine

Prodigy Plus® Eclipse® Remote Cooled Modular Cube Ice Machine

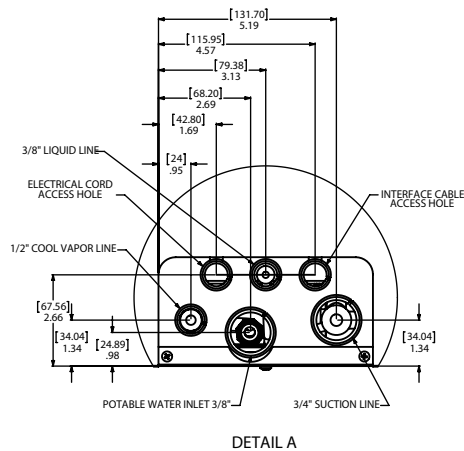
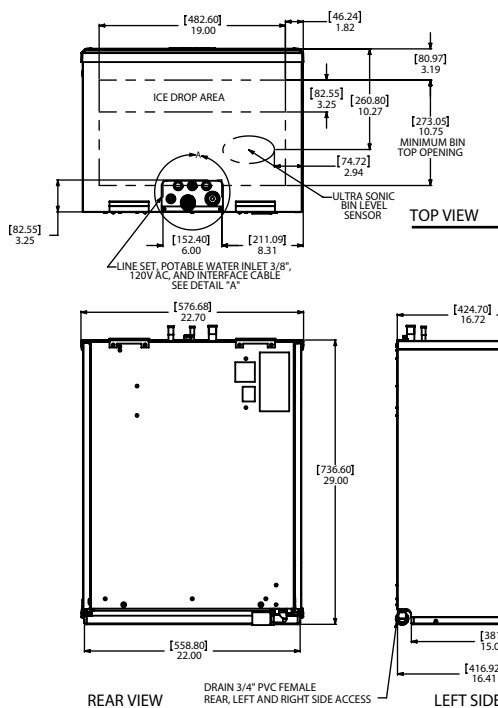

Specifications

Ice Head Model Number	Condenser Unit Model Number	Basic Electrical Volts/Hz/Phase	Max. Fuse Size or HACR Circuit Breaker (amps)	Circuit Wires	Min. Circuit Ampacity	Energy Consumption kWh/100 lb (45.4 kg) 90°F(32°C)/70°F(21°C)	Water Usage Gallons/100 lb (liters/45.4 kg)	
							Potable 90°F(32°C)/70°F(21°C)	Condenser 90°F(32°C)/70°F(21°C)
EH222SL-1	-	115/60/1	15	2	Cord	-	-	-
-	ECC1410-32	208-230/60/1	30	2	15.8	4.98	18.0/68.1	-
-	ECC0800-3	208-230/60/3	15	3	10.6	5.20	18.0/68.1	-
-	ECC1410-3	208-230/60/3	20	3	11.6	4.98	18.0/68.1	-
-	ECC0800-6	230/50/1	20	2	16.8	5.20	18.0/68.1	-



All Models

Dimensions (W x D x H):

EH222 Unit:	22" x 16.5" x 29" (55.9 x 41.9 x 73.7 cm)
Shipping Carton:	25" x 20" x 35" (63.5 x 50.8 x 88.9 cm)
Condenser Unit:	39" x 32" x 40" (99.1 x 81.3 x 101.6 cm)
Shipping Carton:	42" x 34" x 46" (106.7 x 86.4 x 116.8 cm)
Shipping Weight:	EH222 118 lb / 54 kg ECC0800 319 lb / 145 kg ECC1410 332 lb / 151 kg
BTUs per hour:	EH222 800 lb : 13,700 EH222 1000 lb : 20,000
Refrigerant:	R-404A



Accessories

Model Number	Description
KSBU	Smart-Board™ Advanced Control - Use additional operational data for fast diagnosis.
KSBU-N	Smart-Board™ Advanced Control with Network - Network capable.
3BRTE20-EH	Line set, 20ft. Refrigerant and Brazing required
3BRTE35-EH	Line set, 35ft. Refrigerant and Brazing required
3BRTE50-EH	Line set, 50ft. Refrigerant and Brazing required
3BRTE75-EH	Line set, 75ft. Refrigerant and Brazing required

Scotsman recommends all ice machines have water filtration. See Scotsman water filter specification sheet for details.



Operating Requirements

	Minimum	Maximum
Air Temperatures	50°F (10°C)	100°F (38°C)
Water Temperatures	40°F (4.4°C)	100°F (38°C)
Remote Cond. Temps	-20°F (-29°C)	120°F (49°C)
Water Pressures	20 PSIG (1.4 bar)	80 PSIG (5.5 bar)
Electrical Voltage	-5%	+10%

Specifications and design are subject to change without notice.

EH222 - 800-1000lb Cube Ice Machine

• 101 Corporate Woods Parkway, Vernon Hills, IL 60061 •

• 1-800-SCOTSMAN • Fax: 847-913-9844 • www.scotsman-ice.com • customer.relations@scotsman-ice.com •

Scotsman®