



Item # \_\_\_\_\_

We put space to work.

Job \_\_\_\_\_

## SmartLever™ Productivity System

Metro's SmartLever Productivity System is the ultimate storage and productivity solution providing you with:

**More Storage Capacity:** SmartLever's cantilevered design provides unobstructed access to the shelves which can mean 30-50% more storage capacity vs four post shelving in the same foot print\*. Cantilevered shelving also means access to product is unhindered with posts being in the way. Product is easy-to-see and easy-to-access. Shelves are easy-to-load and easy-to-pull from.

**Increased Productivity:** SmartLever allows you to configure a workstation for maximum productivity by providing a variable height work surface with a variety of overhead and under work surface storage options AND a versatile SmartWall grid and accessory system allowing you to optimize the work station for specific tasks.

**Unlimited Flexibility:** Unlike custom fabrication, SmartLever "future proofs" your facility with a flexible system that can be reconfigured and upgraded as your operational needs change. Change is constant and SmartLever adapts with you.

**A Complete System Solution:** Shelving, workstations, and overhead storage all can be configured and integrated together as part of SmartLever's unique system approach to productivity.

### Strength and Confidence:

- Each SmartLever section is capable of supporting a combined load of 2,800 lbs (including the bottom level)
- Each SmartLever cantilevered level (shelf or work surface) is capable of supporting 600 lbs evenly distributed
- Dunnage shelves place on the bottom level are capable of supporting 1,000 lbs evenly distributed
- SmartLever components have a 10 year limited warranty against rust formation
- SmartLever arms include our patent pending ArmKeeper arm location clip

\* Based on items being stored and size of shelving units.



SmartLever Shelving



SmartLever Workstation



SmartLever Shelving Workstation Integration



SmartLever Continuous Shelving



SmartLever Equipment Station



**InterMetro Industries Corporation**  
North Washington Street, Wilkes-Barre, PA 18705  
Product Information. U.S. and Canada: 1.800.992.1776  
Outside U.S. and Canada: www.metro.com/contactus

L03-227  
Printed in U.S.A. 4/20

Information and specifications are subject to change without notice. Please confirm at time of order.

Copyright © 2020 InterMetro Industries Corp.



SmartLever™ Productivity System

17.30



## SmartLever™ Design Guidelines

SmartLever's flexibility comes from its unique, patented design. It's a modular system of Uprights, Legs, Cross Bracing, Arm, Shelves, Work Surfaces, and Accessories that gives you the ability to optimize storage and workspace throughout your facility.

### Uprights & Legs

SmartLever's strength comes from its robust Upright and Leg System. Legs bolt to the upright and can be ordered separately or as part of our convenient Starter and Add-On Kits. Uprights allow Shelves to be adjusted and position on 2" increments.

Part #	Description
<b>SMU76</b>	76" SmartLever Upright
<b>SMU86</b>	86" SmartLever Upright

Part #	Description
<b>SML18</b>	18" Nominal SmartLever Leg
<b>SML21</b>	21" Nominal SmartLever Leg
<b>SML24</b>	24" Nominal SmartLever Leg
<b>SML30</b>	30" Nominal SmartLever Leg



### Cross Brace Kits

SmartLever's stability comes from its Cross Bracing System. Each Cross Brace Kit which consists of two Cross Bars and a set of Cross Bracing.

Part #	Description
<b>SMB24</b>	24" Nominal SmartLever Cross Brace Kit w/Hardware
<b>SMB30</b>	30" Nominal SmartLever Cross Brace Kit w/Hardware
<b>SMB36</b>	36" Nominal SmartLever Cross Brace Kit w/Hardware
<b>SMB42</b>	42" Nominal SmartLever Cross Brace Kit w/Hardware
<b>SMB48</b>	48" Nominal SmartLever Cross Brace Kit w/Hardware
<b>SMB54</b>	54" Nominal SmartLever Cross Brace Kit w/Hardware
<b>SMB60</b>	60" Nominal SmartLever Cross Brace Kit w/Hardware
<b>SMB72</b>	72" Nominal SmartLever Cross Brace Kit w/Hardware



### Arms

SmartLever's **Patent Pending** Arm Design holds heavy loads, is more durable, can hold different width shelves on the same arm, and come with ArmKeepers installed for the ultimate in adjustability and security. Sold as pairs or as singles ("-ADD" parts) SmartLever Arms also come with Shelf Mounting Hooks and Locking Wedges

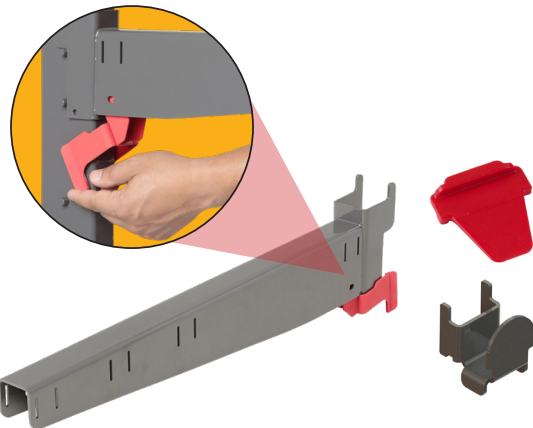

Part #	Description	# of Arms	# of Shelf Mount Hooks	# of Locking Wedges
<b>SMA14A</b>	Pair 14" SmartLever Arms	2	4	4
<b>SMA14A-ADD</b>	Single 14" SmartLever Arm	1	4	4
<b>SMA18A</b>	Pair 18" SmartLever Arms	2	4	4
<b>SMA18A-ADD</b>	Single 18" SmartLever Arm	1	4	4
<b>SMA21A</b>	Pair 21" SmartLever Arms	2	4	4
<b>SMA21A-ADD</b>	Single 21" SmartLever Arm	1	4	4
<b>SMA24A</b>	Pair 24" SmartLever Arms	2	4	4
<b>SMA24A-ADD</b>	Single 24" SmartLever Arm	1	4	4
<b>SMA30A</b>	Pair 30" SmartLever Arms	2	4	4
<b>SMA30A-ADD</b>	Single 30" SmartLever Arm	1	4	4

## SmartLever™ Design Guidelines Cont.

### Shelves

SmartLever's ultimate flexibility comes from the use of Standard Metro Shelving. All Super Erecta (round post) shelves work with SmartLever's Shelf Mounting Hooks.

1. Select Super Erecta Pro shelving for all-around superior performance in all environments based on its easy-to-clean removable mat designs and inherent corrosion protection.
2. Choose Super Erecta for basic applications. Metroseal 3 is recommended but all wire shelving finishes are compatible
3. Utilize Super Erecta Solid Shelving for hybrid work surfaces, work surface overhead shelves, or anytime spill mitigation is important. Stainless steel is recommended for use with SmartLever but all solid shelving styles are compatible
4. Super Erecta Dunnage hold heavy loads supported on SmartLever's Legs with the used of Single or Double Leg Hooks (also for use with other style shelves mounted on the Legs of the unit). Dunnage shelves hold 1,000lbs when mounted to Legs using Leg Hook (must order separately – see below) and 600lbs when mounted to Arms.



Super Erecta Pro



Super Erecta Solid Stainless Steel

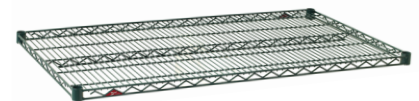

Super Erecta MetroSeal 3



Super Erecta Stainless Steel, Brite or Chrome Finish

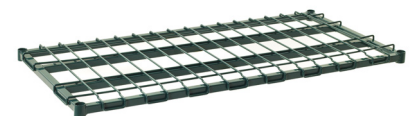

Super Erecta MetroSeal 3 Dunnage

Shelving Size L x W (in.)	Super Erecta Pro	Super Erecta Solid Stainless	Super Erecta Metroseal 3	Super Erecta Super Brite	Super Erecta Chrome	Super Erecta Stainless	Super Erecta Metroseal 3 Dunnage
14 24	-	1424FS	1424NK3	1424BR	1424NC	1424NS	-
14 30	-	1430FS	1430NK3	1430BR	1430NC	1430NS	-
14 36	-	1436FS	1436NK3	1436BR	1436NC	1436NS	-
14 42	-	1442FS	1442NK3	1442BR	1442NC	1442NS	-
14 48	-	1448FS	1448NK3	1448BR	1448NC	1448NS	-
14 54	-	-	1454NK3	1454BR	1454NC	1454NS	-
14 60	-	1460FS	1460NK3	1460BR	1460NC	1460NS	-
14 72	-	-	1472NK3	1472BR	1472NC	1472NS	-
18 24	PR1824NK3	1824FS	1824NK3	1824BR	1824NC	1824NS	1824DRK3
18 30	PR1830NK3	1830FS	1830NK3	1830BR	1830NC	1830NS	1830DRK3
18 36	PR1836NK3	1836FS	1836NK3	1836BR	1836NC	1836NS	1836DRK3
18 42	PR1842NK3	1842FS	1842NK3	1842BR	1842NC	1842NS	1842DRK3
18 48	PR1848NK3	1848FS	1848NK3	1848BR	1848NC	1848NS	1848DRK3
18 54	PR1854NK3	-	1854NK3	1854BR	1854NC	1854NS	1854DRK3
18 60	PR1860NK3	1860FS	1860NK3	1860BR	1860NC	1860NS	1860DRK3
18 72	PR1872NK3	1872FS	1872NK3	1872BR	1872NC	1872NS	-
21 24	PR2124NK3	2124FS	2124NK3	2124BR	2124NC	2124NS	2124DRK3
21 30	PR2130NK3	2130FS	2130NK3	2130BR	2130NC	2130NS	2130DRK3
21 36	PR2136NK3	2136FS	2136NK3	2136BR	2136NC	2136NS	2136DRK3
21 42	PR2142NK3	2142FS	2142NK3	2142BR	2142NC	2142NS	2142DRK3
21 48	PR2148NK3	2148FS	2148NK3	2148BR	2148NC	2148NS	2148DRK3
21 54	PR2154NK3	-	2154NK3	2154BR	2154NC	2154NS	2154DRK3
21 60	PR2160NK3	2160FS	2160NK3	2160BR	2160NC	2160NS	2160DRK3
21 72	PR2172NK3	-	2172NK3	2172BR	2172NC	2172NS	-
24 24	PR2424NK3	2424FS	2424NK3	2424BR	2424NC	2424NS	2424DRK3
24 30	PR2430NK3	2430FS	2430NK3	2430BR	2430NC	2430NS	2430DRK3
24 36	PR2436NK3	2436FS	2436NK3	2436BR	2436NC	2436NS	2436DRK3
24 42	PR2442NK3	2442FS	2442NK3	2442BR	2442NC	2442NS	2442DRK3
24 48	PR2448NK3	2448FS	2448NK3	2448BR	2448NC	2448NS	2448DRK3
24 54	PR2454NK3	-	2454NK3	2454BR	2454NC	2454NS	2454DRK3
24 60	PR2460NK3	2460FS	2460NK3	2460BR	2460NC	2460NS	2460DRK3
24 72	PR2472NK3	2472FS	2472NK3	2472BR	2472NC	2472NS	-
30 36	-	-	3036NK3	-	3036NC	3036NS	-
30 42	-	-	3042NK3	-	3042NC	-	-
30 48	-	-	3048NK3	-	3048NC	3048NS	-
30 54	-	-	3054NK3	-	3054NC	-	-
30 60	-	-	3060NK3	-	3060NC	3060NS	-
30 72	-	-	3072NK3	-	3072NC	3072NS	-

### Leg Hooks

Leg hooks are used to install any shelf on the legs as the bottom shelf of the unit.



Cat. No.	Description
LSH1	Single Leg Hook (4 Pack)
LSH2	Double Leg Hook (2 Pack)

\*Arm size must match shelf depth. For example, 2148NK3 shelf will use SMA 21A.



## SmartLever™ Design Guidelines Cont.

### Work Surfaces

Create a versatile and productive work station with SmartLever Work Surfaces. Work Surfaces are 304 16ga Stainless Steel with a 4" seamless back splash and mount over 30" Shelves (30" Arms and 30" deep Shelves must be ordered separately with the work surface). Work surface heights can be set at any height in 2" increments for optimal ergonomics and work flow. Work surfaces include a sound deadening inlay and support 600lbs evenly distributed.

Cat. No.	Description	Approx. Pkd. Wt. (lbs.)	Approx. Pkd. Wt. (kg)	Width (in)	Length (in)
<b>SMW36</b>	SmartLever 30x36 SS Work Surface	33.6	15.3	30.25	39.75
<b>SMW42</b>	SmartLever 30x42 SS Work Surface	38.3	17.5	30.25	45.75
<b>SMW48</b>	SmartLever 30x48 SS Work Surface	42.9	19.5	30.25	51.75
<b>SMW54</b>	SmartLever 30x54 SS Work Surface	47.6	21.3	30.25	57.75
<b>SMW60</b>	SmartLever 30x60 SS Work Surface	52.2	23.8	30.25	63.75
<b>SMW72</b>	SmartLever 30x72 SS Work Surface	61.4	28	30.25	75.75

\*Work surfaces need a 30" deep shelf and a pair of 30" arms, which must be ordered separately.

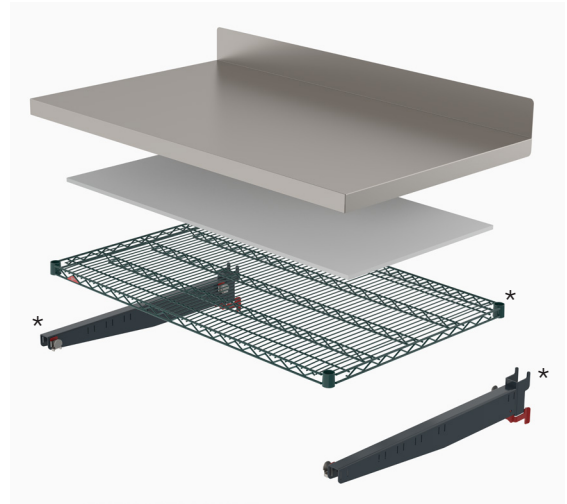

### SmartWall Grids & Brackets

SmartWall Grids can be added to SmartLever Work Stations to accommodate SmartWall Accessories (See SmartWall Accessories Spec Sheet 10.43) for the ultimate in customized productivity!

#### Accessory Grids

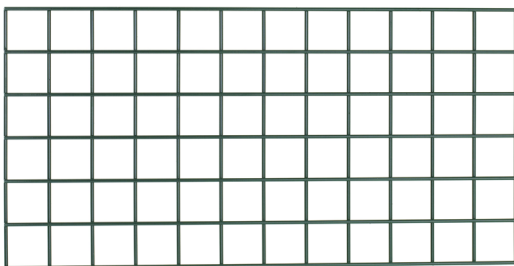

Grid Size (in)	MetroSeal 3
Width Length	Part #
18 24	<b>WG1824K3</b>
18 30	<b>WG1830K3</b>
18 36	<b>WG1836K3</b>
18 42	<b>WG1842K3</b>
18 48	<b>WG1848K3</b>
18 54	<b>WG1854K3</b>
18 60	<b>WG1860K3</b>
18 72	<b>WG1872K3</b>
24 36	<b>WG2436K3</b>
24 48	<b>WG2448K3</b>
30 36	<b>WG3036K3</b>
30 48	<b>WG3048K3</b>



\* Shown with SmartWall Accessories (Not included within specifications)

#### Grid Bracket

Cat. No.	Description
<b>SMR*</b>	SmartLever Grid Bracket (4 pack)

\*must be purchased if ordering a grid.



SMR

# SmartLever™ Productivity System

## SmartLever™ Design Guidelines Cont.

### Starter & Add-on Kits

**Starter kits include:** two uprights, two legs, two cross bars, and cross bracing

**Add-On kits include:** one upright, one leg, two cross bars, and cross bracing

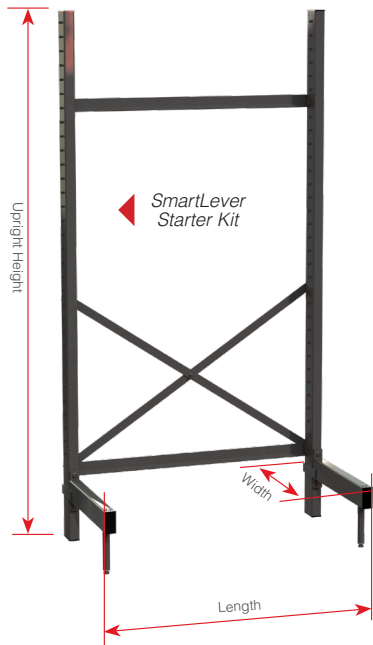

SmartLever Starter Kit	Assembled Unit H x W x L (in.)			Shelving Size L x W (in.)		SmartLever Add-On Kit	Assembled Unit H x W x L (in.)			Shelving Size L x W (in.)	
SM761824-KIT	22.5	28.25	76.38	18	24	SM761824-ADD	22.5	26.188	76.38	18	24
SM761830-KIT	22.5	34.25	76.38	18	30	SM761830-ADD	22.5	32.188	76.38	18	30
SM761836-KIT	22.5	40.25	76.38	18	36	SM761836-ADD	22.5	38.188	76.38	18	36
SM761842-KIT	22.5	46.25	76.38	18	42	SM761842-ADD	22.5	44.188	76.38	18	42
SM761848-KIT	22.5	52.25	76.38	18	48	SM761848-ADD	22.5	50.188	76.38	18	48
SM761854-KIT	22.5	58.25	76.38	18	54	SM761854-ADD	22.5	56.188	76.38	18	54
SM761860-KIT	22.5	64.25	76.38	18	60	SM761860-ADD	22.5	62.188	76.38	18	60
SM761872-KIT	22.5	76.25	76.38	18	72	SM761872-ADD	22.5	74.188	76.38	18	72
SM762124-KIT	25.5	28.25	76.38	21	24	SM762124-ADD	25.5	26.188	76.38	21	24
SM762130-KIT	25.5	34.25	76.38	21	30	SM762130-ADD	25.5	32.188	76.38	21	30
SM762136-KIT	25.5	40.25	76.38	21	36	SM762136-ADD	25.5	38.188	76.38	21	36
SM762142-KIT	25.5	46.25	76.38	21	42	SM762142-ADD	25.5	44.188	76.38	21	42
SM762148-KIT	25.5	52.25	76.38	21	48	SM762148-ADD	25.5	50.188	76.38	21	48
SM762154-KIT	25.5	58.25	76.38	21	54	SM762154-ADD	25.5	56.188	76.38	21	54
SM762160-KIT	25.5	64.25	76.38	21	60	SM762160-ADD	25.5	62.188	76.38	21	60
SM762172-KIT	25.5	76.25	76.38	21	72	SM762172-ADD	25.5	74.188	76.38	21	72
SM762424-KIT	28.5	28.25	76.38	24	24	SM762424-ADD	28.5	26.188	76.38	24	24
SM762430-KIT	28.5	34.25	76.38	24	30	SM762430-ADD	28.5	32.188	76.38	24	30
SM762436-KIT	28.5	40.25	76.38	24	36	SM762436-ADD	28.5	38.188	76.38	24	36
SM762442-KIT	28.5	46.25	76.38	24	42	SM762442-ADD	28.5	44.188	76.38	24	42
SM762448-KIT	28.5	52.25	76.38	24	48	SM762448-ADD	28.5	50.188	76.38	24	48
SM762454-KIT	28.5	58.25	76.38	24	54	SM762454-ADD	28.5	56.188	76.38	24	54
SM762460-KIT	28.5	64.25	76.38	24	60	SM762460-ADD	28.5	62.188	76.38	24	60
SM762472-KIT	28.5	76.25	76.38	24	72	SM762472-ADD	28.5	74.188	76.38	24	72
SM763024-KIT	34.5	28.25	76.38	30	24	SM763024-ADD	34.5	26.188	76.38	30	24
SM763030-KIT	34.5	34.25	76.38	30	30	SM763030-ADD	34.5	32.188	76.38	30	30
SM763036-KIT	34.5	40.25	76.38	30	36	SM763036-ADD	34.5	38.188	76.38	30	36
SM763042-KIT	34.5	46.25	76.38	30	42	SM763042-ADD	34.5	44.188	76.38	30	42
SM763048-KIT	34.5	52.25	76.38	30	48	SM763048-ADD	34.5	50.188	76.38	30	48
SM763054-KIT	34.5	58.25	76.38	30	54	SM763054-ADD	34.5	56.188	76.38	30	54
SM763060-KIT	34.5	64.25	76.38	30	60	SM763060-ADD	34.5	62.188	76.38	30	60
SM763072-KIT	34.5	76.25	76.38	30	72	SM763072-ADD	34.5	74.188	76.38	30	72
SM861824-KIT	22.5	28.25	86.38	18	24	SM861824-ADD	22.5	26.188	86.38	18	24
SM861830-KIT	22.5	34.25	86.38	18	30	SM861830-ADD	22.5	32.188	86.38	18	30
SM861836-KIT	22.5	40.25	86.38	18	36	SM861836-ADD	22.5	38.188	86.38	18	36
SM861842-KIT	22.5	46.25	86.38	18	42	SM861842-ADD	22.5	44.188	86.38	18	42
SM861848-KIT	22.5	52.25	86.38	18	48	SM861848-ADD	22.5	50.188	86.38	18	48
SM861854-KIT	22.5	58.25	86.38	18	54	SM861854-ADD	22.5	56.188	86.38	18	54
SM861860-KIT	22.5	64.25	86.38	18	60	SM861860-ADD	22.5	62.188	86.38	18	60
SM861872-KIT	22.5	76.25	86.38	18	72	SM861872-ADD	22.5	74.188	86.38	18	72
SM862124-KIT	25.5	28.25	86.38	21	24	SM862124-ADD	25.5	26.188	86.38	21	24
SM862130-KIT	25.5	34.25	86.38	21	30	SM862130-ADD	25.5	32.188	86.38	21	30
SM862136-KIT	25.5	40.25	86.38	21	36	SM862136-ADD	25.5	38.188	86.38	21	36
SM862142-KIT	25.5	46.25	86.38	21	42	SM862142-ADD	25.5	44.188	86.38	21	42
SM862148-KIT	25.5	52.25	86.38	21	48	SM862148-ADD	25.5	50.188	86.38	21	48
SM862154-KIT	25.5	58.25	86.38	21	54	SM862154-ADD	25.5	56.188	86.38	21	54
SM862160-KIT	25.5	64.25	86.38	21	60	SM862160-ADD	25.5	62.188	86.38	21	60
SM862172-KIT	25.5	76.25	86.38	21	72	SM862172-ADD	25.5	74.188	86.38	21	72
SM862424-KIT	28.5	28.25	86.38	24	24	SM862424-ADD	28.5	26.188	86.38	24	24
SM862430-KIT	28.5	34.25	86.38	24	30	SM862430-ADD	28.5	32.188	86.38	24	30
SM862436-KIT	28.5	40.25	86.38	24	36	SM862436-ADD	28.5	38.188	86.38	24	36
SM862442-KIT	28.5	46.25	86.38	24	42	SM862442-ADD	28.5	44.188	86.38	24	42
SM862448-KIT	28.5	52.25	86.38	24	48	SM862448-ADD	28.5	50.188	86.38	24	48
SM862454-KIT	28.5	58.25	86.38	24	54	SM862454-ADD	28.5	56.188	86.38	24	54
SM862460-KIT	28.5	64.25	86.38	24	60	SM862460-ADD	28.5	62.188	86.38	24	60
SM862472-KIT	28.5	76.25	86.38	24	72	SM862472-ADD	28.5	74.188	86.38	24	72
SM863024-KIT	34.5	28.25	86.38	30	24	SM863024-ADD	34.5	26.188	86.38	30	24
SM863030-KIT	34.5	34.25	86.38	30	30	SM863030-ADD	34.5	32.188	86.38	30	30
SM863036-KIT	34.5	40.25	86.38	30	36	SM863036-ADD	34.5	38.188	86.38	30	36
SM863042-KIT	34.5	46.25	86.38	30	42	SM863042-ADD	34.5	44.188	86.38	30	42
SM863048-KIT	34.5	52.25	86.38	30	48	SM863048-ADD	34.5	50.188	86.38	30	48
SM863054-KIT	34.5	58.25	86.38	30	54	SM863054-ADD	34.5	56.188	86.38	30	54
SM863060-KIT	34.5	64.25	86.38	30	60	SM863060-ADD	34.5	62.188	86.38	30	60
SM863072-KIT	34.5	76.25	86.38	30	72	SM863072-ADD	34.5	74.188	86.38	30	72

# SmartLever™ Productivity System

We put space to work.®

## Specifications

- Structure: Heavy gauge cold rolled steel electroplated and epoxy coated with stainless steel hardware.
- Work Surface: 16 gauge, type 304 stainless steel top with Duraplast anti-drumming support.
- Support Arms: 11 gauge, steel coated with epoxy.
- Dunnage: heavy gauge cold rolled steel electroplated and epoxy coated
- General: work surface and shelving height adjustable on 2" increments.
- Warranty: 10 year limited warranty against surface rust formation.
- Load Capacity:
  - The total weight load capacity of each model including the bottom shelf, is 2,800 lbs. (1271kg).
  - Each level (work surface or shelf) has an evenly distributed weight load capacity of 600 lbs. (272kg).
  - The maximum uniformly distributed load on the Dunnage rack must not exceed 1,000 lbs. (454kg).

## Configuring SmartLever™

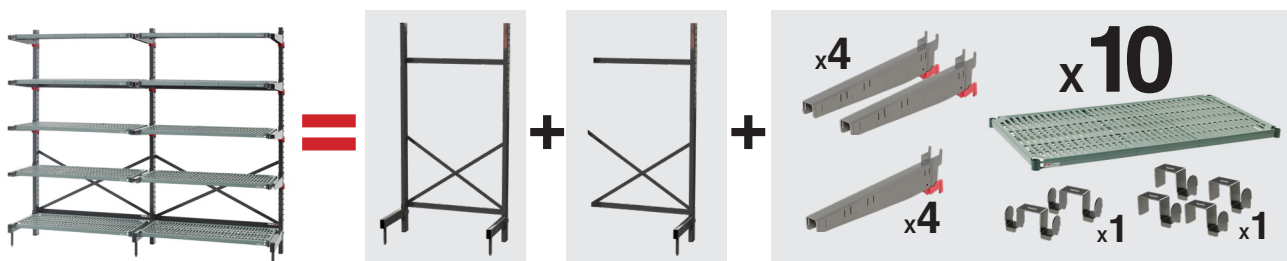

Quantity Needed	Cat. No.	Description
1	<b>SM762448-KIT</b>	SmartLever 21x48 Starter Unit Kit
1	<b>SM762448-ADD</b>	SmartLever 21x48 Add-on Unit Kit
4	<b>SMA24A</b>	Pair 21" SmartLever Arms

Quantity Needed	Cat. No.	Description
4	<b>SMA24A-ADD</b>	Single 21" SmartLever Arms
10	<b>PR2148NK3</b>	21x48 Super Erecta Pro Shelf
1	<b>LSH1</b>	Single Leg Hook (4 Pack)
1	<b>LSH2</b>	Double Leg Hook (2 Pack)

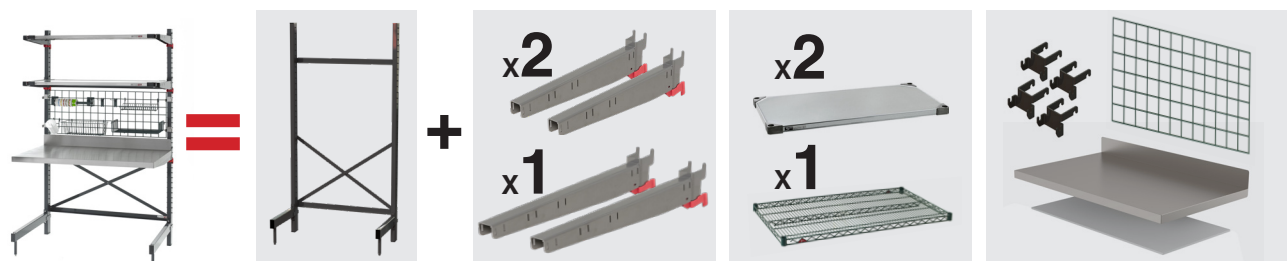

Quantity Needed	Cat. No.	Description
1	<b>SM763042-KIT</b>	SmartLever 30x42 Starter Unit Kit
1	<b>SMW42</b>	SmartLever 30x42 SS Work Surface
1	<b>3042NK3</b>	30x42 Epoxy Coated Wire Shelf
2	<b>SMA18A</b>	Pair 18" SmartLever Arms

Quantity Needed	Cat. No.	Description
1	<b>SMA30A</b>	Pair 30" SmartLever Arms
1	<b>WG1842K3</b>	18x42 SmartWall Accessory Grid
1	<b>SMR</b>	SmartLever Grid Bracket (4 pack)
2	<b>1842FS</b>	18x42 Flat Stainless Steel Shelf

Note: Grid accessories are not included and can be ordered separately

an Ali Group Company



The Spirit of Excellence