



18 GAUGE STAINLESS STEEL

FE SERIES - FABRICATED SINKS



Three & Four Compartments



Rolled Rim Edge For Additional Strength

Item #: _____ Qty #: _____
 Model #: _____
 Project #: _____

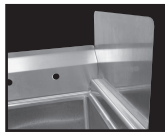

K-700
 Removable Side Splashes
 Fits Left OR Right Side

	MODEL #	Length L	Width W	Bowl Size A & B	Bowl Depth	Drbd. Length Size	# of Drbrds.	Drbrd. Location	Wt.	Approx. Cubes
3 COMP.	FE-3-1515-X	50"	20 3/4"	15"x15"	12"	N/A	0	None	95 lbs.	25
	FE-3-1515-15RorLX	62 1/2"	20 3/4"		12"	15"	1	R or L	105 lbs.	31
	FE-3-1515-15RLX	75"	20 3/4"		12"	15"	2	R & L	115 lbs.	31
	FE-3-1620-X	53"	25 3/4"	16"x20"	12"	N/A	0	None	88 lbs.	25
	FE-3-1620-18RorLX	68 1/2"	25 3/4"		12"	18"	1	R or L	96 lbs.	38
	FE-3-1620-18RLX	84"	25 3/4"		12"	18"	2	R & L	105 lbs.	42
	FE-3-1614-18RLX	84"	25 3/4"		14"	18"	2	R & L	115 lbs.	42
	FE-3-1812-X	59"	23 3/4"	18"x18"	12"	N/A	0	None	90 lbs.	22
	FE-3-1812-18RorL-X	74 1/2"	23 3/4"		12"	18"	1	R or L	102 lbs.	29
	FE-3-1812-18RLX	90"	23 3/4"		12"	18"	2	R & L	110 lbs.	42
	FE-3-1812-24RLX	102"	23 3/4"		12"	24"	2	R & L	149 lbs.	46
	FE-3-1814-18RLX	90"	23 3/4"		14"	18"	2	R & L	140 lbs.	42
	FE-3-1814-24RLX	102"	23 3/4"		14"	24"	2	R & L	160 lbs.	43
	FE-3-1824-18RLX	90"	29 3/4"	18"x24"	14"	18"	2	R & L	240 lbs.	47
	FE-3-1824-24RorLX	80 1/2"	29 3/4"		14"	24"	1	R or L	242 lbs.	50
FE-3-1824-24RLX	102"	29 3/4"	14"		24"	2	R & L	250 lbs.	54	
FE-3-2424-X*	79"	29 3/4"	24"x24"	14"	N/A	0	None	300 lbs.	47	
FE-3-2424-24RorL-X*	98 1/2"	29 3/4"		14"	24"	1	R or L	328 lbs.	67	
FE-3-2424-24RLX*	120"	29 3/4"		14"	24"	2	R & L	340 lbs.	67	
4 COMP.	FE-4-1812-18RLX*	108"	23 3/4"	18"x18"	12"	18"	2	R & L	250 lbs.	67
SPACE SAVER	FE-3-1014-X	35"	19 3/4"	10"x14"	10"	N/A	0	None	85 lbs.	18
	FE-3-1014-15RLX	60"	19 3/4"		10"	15"	2	R & L	98 lbs.	22
	FE-3-1416-12RLX	66"	21 3/4"	14"x16"	12"	12"	2	R & L	92 lbs.	42

* Requires Two Faucets

FEATURES:

- Backsplash has tile edge for ease of installation.
- Sink bowls are 3/4" coved corner and meet NSF requirements.
- Rolled Rim Edge for additional strength.
- 10"x14 Sink Bowls are 10" deep.
- 14"x16", 15"x15", 16"x20" & 18"x18" Sink Bowls are 12" deep.
- 18"x24" & 24"x24" Sink Bowls are 14" deep.
- 9" Backsplash.

CONSTRUCTION:

- All TIG welded.
- Welded areas blended to match adjacent surfaces and to a satin finish.
- Gussets welded to a die-embossed reinforced plate.

MATERIAL:

- 1 5/8" diameter galvanized legs with 1" adjustable plastic bullet feet.
- Entire unit is 18 gauge 304 stainless steel.
- Gussets - galvanized steel.

MECHANICAL:

- Supply is 1/2" IPS hot & cold.
- Faucet holes on 8" centers.
- Faucets are not included (**see accessories**).
- Waste drains are 1 1/2" IPS S/S basket type, located in center of sink bowl, and are included.

OPTIONAL:

- FE-SS-12** S/S Leg Upgrade For Sinks w/ 12" Deep Bowls
- FE-SS-14** S/S Leg Upgrade For Sinks w/ 14" Deep Bowls



Customer Service Available To Assist You **1-800-645-3166** 8:30 am - 7:00 pm E.S.T.

For Orders & Customer Service:

Email: customer@advancetabco.com or Fax: 631-242-6900

For Smart Fabrication™ Quotes:

Email: smartfab@advancetabco.com or Fax: 631-586-2933

DIMENSIONS and SPECIFICATIONS

TOL Overall: $\pm .500''$ Interior: $\pm .250''$

ALL DIMENSIONS ARE TYPICAL

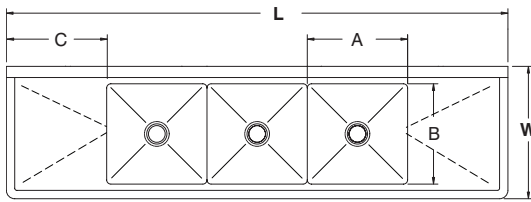

3 COMP - 2 DRBD

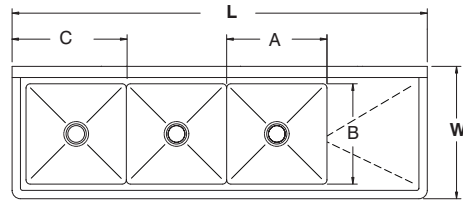

3 COMP - 1 DRBD

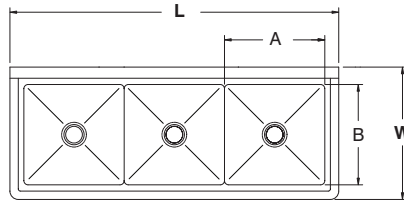

3 COMP

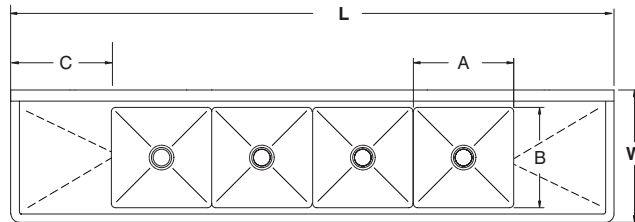

4 COMP - 2 DRBD

ACCESSORIES	Model #	Qty
DRAINS		
FAUCETS		

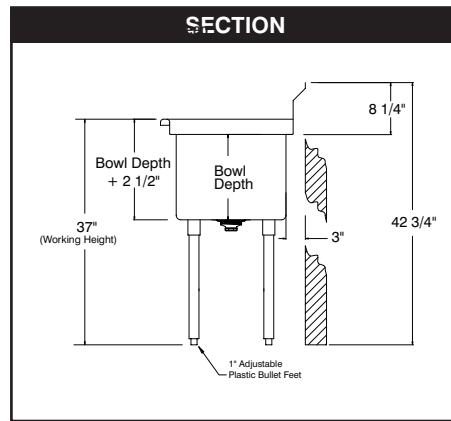
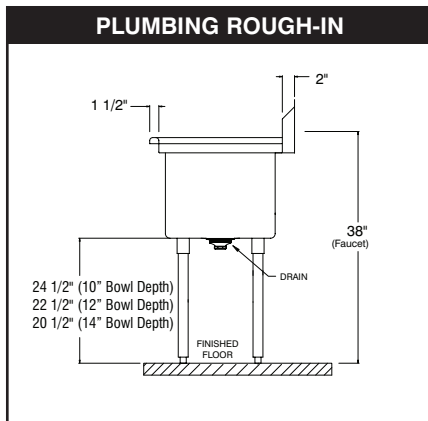

ADVANCE TABCO is constantly engaged in a program of improving our products. Therefore, we reserve the right to change specifications without prior notice.