



Profit from the Eagle Advantage®

Specification Sheet

Short Form Specifications

Eagle Wire Shelf, model _____. (EAGLEbrite® Zinc, Chrome, Valu-Master® Grey Epoxy, Valu-Gard® Green Epoxy, EAGLEgard® Green Epoxy with MICROGARD®, or Stainless steel electropolished) finish. Patented QuadTruss® design, with mat wires welded to a four-truss assembly on front and back, and a three-truss assembly on each end.

Eagle Post, model _____. (EAGLEbrite® Zinc, Chrome, Valu-Master® Grey Epoxy, Valu-Gard® Green Epoxy, EAGLEgard® Green Epoxy with MICROGARD®, or Stainless steel) finish. Post is 1" diameter, numerically grooved in 1" increments, and includes post cap and leveling bolt.

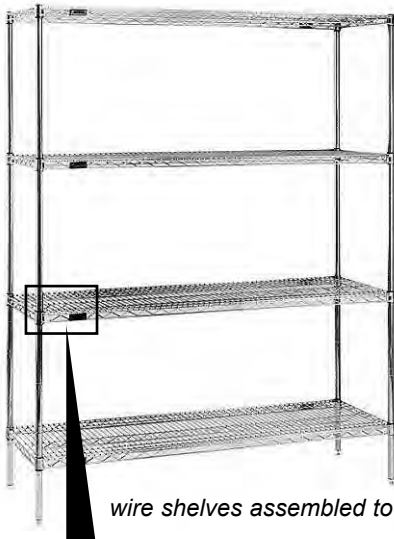

wire shelves assembled to posts

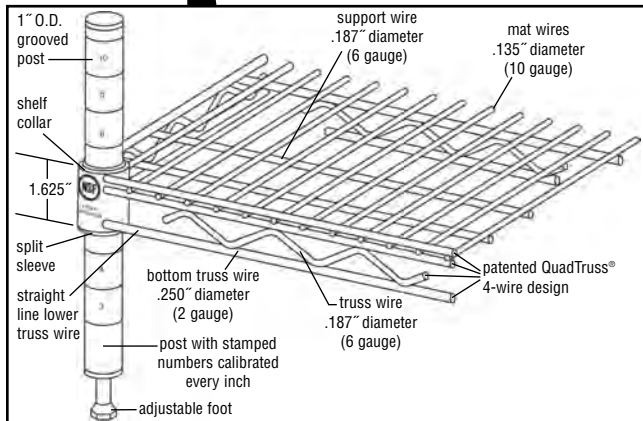

EAGLE GROUP
 100 Industrial Boulevard, Clayton, DE 19938-8903 USA
 Phone: 302-653-3000 • Fax: 302-653-2065
 www.eaglegrp.com • www.eaglemhc.com

Foodservice Division: Phone 800-441-8440
MHC Division: Phone 800-637-5100

For custom configuration or fabrication needs, contact our **SpecFAB® Division**.
 Phone: 302-653-3000 • Fax: 302-653-2065 • e-mail: quotes@eaglegrp.com

Spec sheets available for viewing, printing or downloading from our online literature library at www.eaglegrp.com

Eagle Foodservice Equipment, Eagle MHC, and SpecFAB® are divisions of Eagle Group. ©2020 by the Eagle Group

Item No.: _____
 Project No.: _____
 S.I.S. No.: _____

Wire Shelving

MODELS:

- 14*
- 24*
- P7-*
- P33-*
- P74-*
- 18*
- 30*
- P14-*
- P54-*
- P86-*
- 21*
- 36*
- P18-*
- P63-*
- P96-*

* See charts for complete model numbers.

- Patented QuadTruss® design (patent #5,390,803) makes EAGLE shelves up to 25% stronger and provides a retaining ledge for increased storage stability and product retention.
- Assembly: numerically calibrated grooved posts, tapered plastic split sleeves and shelf collars combine to make shelving assembly a simple two-step exercise: 1) Snap the split sleeves onto a post over the number of your choice; and 2) slide a shelf collar over the split sleeves. A positive lock between shelf and post is created without the use of any tools.
- Open-wire construction promotes higher visibility, allows light to pass through the shelves, permits greater air circulation which helps reduce moisture and dust build-up, and increases the effectiveness of fire-suppression systems.
- Tapered split sleeves of high-temperature-resistant ABS plastic create a positive lock that becomes stronger as the load increases.
- Posts are numbered in increments of 1" (25mm) to ensure fast and level assembly.
- Leveling feet are provided to help compensate for uneven floor surfaces.
- Shelf strength: shelf mat utilizes a pincer-type design with the mat wire sandwiched between the two top truss wires, adding significant strength and distributing the entire load without stress and strain on the welds.
- Weight capacities: 800 lbs. (363 kg) for shelves up to 48" (1219mm)-long, evenly distributed static load. 600 lbs. (272 kg) for shelves 54" through 72" (1372 through 1829mm)-long. Shelving units should not exceed 2400 lbs. (1089 kg) per set of four posts.
- Packaging: 24" (610mm) through 48" (1219mm) lengths are packed four to a box. 54", 60" and 72" (1372, 1524 and 1829mm) lengths are packed two to a box.

Options / Accessories

- Casters
- Ledges
- Aluminum split sleeves
- Foot plates
- Dividers
- Shelf markers
- "S" hooks
- Rods and tabs

Certifications / Approvals



Government specifications
 MIL-S-40144E





Profit from the Eagle Advantage®

Item No.: _____
 Project No.: _____
 S.I.S. No.: _____

Wire Shelves

EAGLE brite®	chrome	Valu-Master®	Valu-Gard®	EAGLE gard®*	stainless steel	width in.	length in.	width mm	length mm	weight lb.	weight kg
1424Z	1424C	1424V	1424VG	1424E	1424S	14"	24"	356	610	6	2.7
1430Z	1430C	1430V	1430VG	1430E	1430S	14"	30"	356	762	7	3.2
1436Z	1436C	1436V	1436VG	1436E	1436S	14"	36"	356	914	8	3.6
1442Z	1442C	1442V	1442VG	1442E	1442S	14"	42"	356	1067	9	4.1
1448Z	1448C	1448V	1448VG	1448E	1448S	14"	48"	356	1219	10	4.6
1454Z	1454C	1454V	1454VG	1454E	1454S	14"	54"	356	1372	12	5.5
1460Z	1460C	1460V	1460VG	1460E	1460S	14"	60"	356	1524	14	6.4
1472Z	1472C	1472V	1472VG	1472E	1472S	14"	72"	356	1829	17	7.7
1824Z	1824C	1824V	1824VG	1824E	1824S	18"	24"	457	610	7	3.2
1830Z	1830C	1830V	1830VG	1830E	1830S	18"	30"	457	762	8	3.6
1836Z	1836C	1836V	1836VG	1836E	1836S	18"	36"	457	914	9	4.1
1842Z	1842C	1842V	1842VG	1842E	1842S	18"	42"	457	1067	11	5.0
1848Z	1848C	1848V	1848VG	1848E	1848S	18"	48"	457	1219	12	5.5
1854Z	1854C	1854V	1854VG	1854E	1854S	18"	54"	457	1372	15	6.8
1860Z	1860C	1860V	1860VG	1860E	1860S	18"	60"	457	1524	17	7.7
1872Z	1872C	1872V	1872VG	1872E	1872S	18"	72"	457	1829	20	9.1
2124Z	2124C	2124V	2124VG	2124E	2124S	21"	24"	533	610	8	3.6
2130Z	2130C	2130V	2130VG	2130E	2130S	21"	30"	533	762	9	4.1
2136Z	2136C	2136V	2136VG	2136E	2136S	21"	36"	533	914	11	5.0
2142Z	2142C	2142V	2142VG	2142E	2142S	21"	42"	533	1067	12	5.5
2148Z	2148C	2148V	2148VG	2148E	2148S	21"	48"	533	1219	14	6.4
2154Z	2154C	2154V	2154VG	2154E	2154S	21"	54"	533	1372	16	7.3
2160Z	2160C	2160V	2160VG	2160E	2160S	21"	60"	533	1524	18	8.2
2172Z	2172C	2172V	2172VG	2172E	2172S	21"	72"	533	1829	24	10.9
2424Z	2424C	2424V	2424VG	2424E	2424S	24"	24"	610	610	9	4.1
2430Z	2430C	2430V	2430VG	2430E	2430S	24"	30"	610	762	11	5.0
2436Z	2436C	2436V	2436VG	2436E	2436S	24"	36"	610	914	13	5.9
2442Z	2442C	2442V	2442VG	2442E	2442S	24"	42"	610	1067	15	6.8
2448Z	2448C	2448V	2448VG	2448E	2448S	24"	48"	610	1219	16	7.3
2454Z	2454C	2454V	2454VG	2454E	2454S	24"	54"	610	1372	19	8.6
2460Z	2460C	2460V	2460VG	2460E	2460S	24"	60"	610	1524	21	9.5
2472Z	2472C	2472V	2472VG	2472E	2472S	24"	72"	610	1829	26	11.8
3030Z	3030C	3030V	3030VG	3030E	3030S	30"	30"	762	762	16	7.3
3036Z	3036C	3036V	3036VG	3036E	3036S	30"	36"	762	914	17	7.7
3048Z	3048C	3048V	3048VG	3048E	3048S	30"	48"	762	1219	20	9.1
3060Z	3060C	3060V	3060VG	3060E	3060S	30"	60"	762	1524	25	11.4
3072Z	3072C	3072V	3072VG	3072E	3072S	30"	72"	762	1829	30	13.6
3636Z	3636C	3636V	3636VG	3636E	3636S	36"	36"	914	914	21	9.5
3648Z	3648C	3648V	3648VG	3648E	3648S	36"	48"	914	1219	26	11.8
3660Z	3660C	3660V	3660VG	3660E	3660S	36"	60"	914	1524	34	15.4
3672Z	3672C	3672V	3672VG	3672E	3672S	36"	72"	914	1829	43	19.5

Posts

Numerically grooved in 1" (25mm) increments. Includes post cap and leveling bolt. For mobile application (excluding 96" posts), add prefix "C" to model number. Example: CP14-E. See Spec Sheet #EG01.05A for information about casters available.

EAGLE brite®**	chrome	Valu-Master®	Valu-Gard®	EAGLE gard®*	stainless steel	height in.	height mm	weight lb.	weight kg
P7-Z	P7-C	P7-V	P7-VG	P7-E	P7-S	7"	178	1.0	0.5
P14-Z	P14-C	P14-V	P14-VG	P14-E	P14-S	14"	356	1.0	0.5
P18-Z	P18-C	P18-V	P18-VG	P18-E	P18-S	18"	457	1.5	0.7
P33-Z	P33-C	P33-V	P33-VG	P33-E	P33-S	33"	838	2.0	0.9
P54-Z	P54-C	P54-V	P54-VG	P54-E	P54-S	54"	1372	3.0	1.4
P63-Z	P63-C	P63-V	P63-VG	P63-E	P63-S	63"	1600	3.5	1.6
P74-Z	P74-C	P74-V	P74-VG	P74-E	P74-S	74"	1880	4.0	1.8
P86-Z	P86-C	P86-V	P86-VG	P86-E	P86-S	86"	2184	5.0	2.3
- n/a -	P96-C***	- n/a -	- n/a -	- n/a -	P96-S***	96"	2438	6.0	2.7

* MICROGARD® standard on all EAGLEgard® posts.
 ** EAGLEbrite® posts are clear epoxy coated for use in dry or wet environments.
 *** 96" (2538mm) posts are NOT to be used on units less than 24" (610mm) front-to-back.
 Recommend using in conjunction with foot plates to affix to floor, and with post clamps where applicable. For stationary use only.

EAGLE GROUP

100 Industrial Boulevard, Clayton, DE 19938-8903 USA
 Phone: 302-653-3000 • Fax: 302-653-2065 • www.eaglegrp.com • www.eaglehmc.com
 Foodservice Division: Phone 800-441-8440
 MHC Division: Phone 800-637-5100

Finishes available:

Stainless Steel finish – OUR BEST

• Stainless steel 
 NSF-listed for all environments. Type 304 stainless steel. **15-Year Limited Warranty**
 Note: Stainless steel shelving is electropolished.

Eaglegard® hybrid epoxy

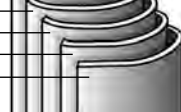
• Zinc chloride
 • Clear chromate
 • MasterSeal® sealer
 • Blue green hybrid epoxy with MICROGARD®* 
 NSF-listed for all environments. Zinc chloride plating followed by clear chromate plating with MasterSeal® sealer, and a final coat of hybrid translucent epoxy with MICROGARD®.
12-Year Limited Warranty

Valu-Master® and Valu-Gard® epoxies

• Phosphate conversion coating
 • MasterSeal® sealer
 • Pewter gray (Valu-Master®) or green (Valu-Gard®) epoxy 
 NSF-listed for wet or dry storage environments. Phosphate conversion coating followed by epoxy coating. **5-Year Limited Warranty**

Chrome

• Bright nickel
 • Chrome
 • Air-dry lacquer 
 NSF-listed for dry storage environments. Bright nickel plating followed by chrome plating.
1-Year Limited Warranty
 (NOTE: Optional clear hybrid epoxy, NSF-listed for all environments, is available.)

Eaglebrite® zinc

• Zinc chloride
 • Clear chromate
 • MasterSeal® sealer 
 NSF-listed for dry storage environments. Bright zinc chloride plating followed by clear chromate plating with MasterSeal® sealer for improved rust protection.
3-Year Limited Warranty
 (NOTE: Wire shelves feature MasterSeal® sealer. NSF-listed for all environments.)

* MICROGARD® is an antimicrobial agent which contains built-in protection to retard the growth of a broad range of bacteria, mold and mildew on the surface of the shelves that cause stains, odors and degradation. **STANDARD ON ALL EAGLEGARD® SHELVING.**

Spec sheets available for viewing, printing or downloading from our online literature library at www.eaglegrp.com

Although every attempt has been made to ensure the accuracy of the information provided, we cannot be held responsible for typographical or printing errors. Information and specifications are subject to change without notice. Please confirm at time of order.